

# IOLA

by e-ggs

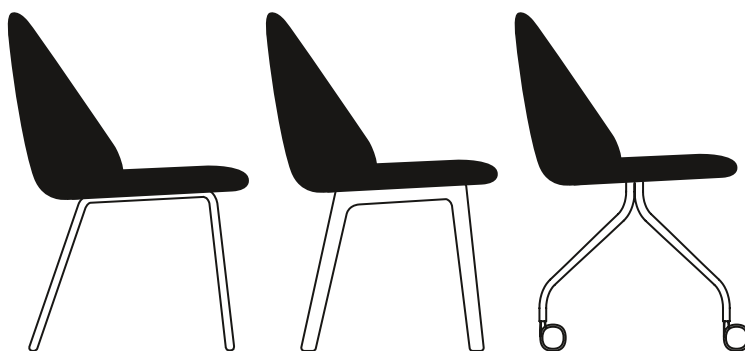

**lola vive il design con un approccio internazionale, concentrandosi sull'ergonomia delle forme, mantenendo un aspetto curato e caratterizzante. Abbiamo dato alla scocca la forma di un guscio, producendola in poliuretano espanso. Sotto consiglio dei più esigenti, poi, le abbiamo tirato le orecchie così sono usciti due grandi braccioli. lola sa di moda, ma si propone come un classico contemporaneo.**

**lola shows off design with an international approach, focusing on the ergonomics of the form, ensuring a careful look, one with character. We have given the body the shape of a shell, producing it in expanded polyurethane. Then, on the advice of the hardest to please, we pulled the wings and then the two large arms came out. lola hints at fashion but comes across as a modern classic.**

## DIMENSIONI | DIMENSIONS

### IOLA BASIC

lunghezza | width: 52 cm  
larghezza | depth: 58,2 cm  
altezza | height: 83,1 cm  
altezza del sedile | seat height: 47 cm

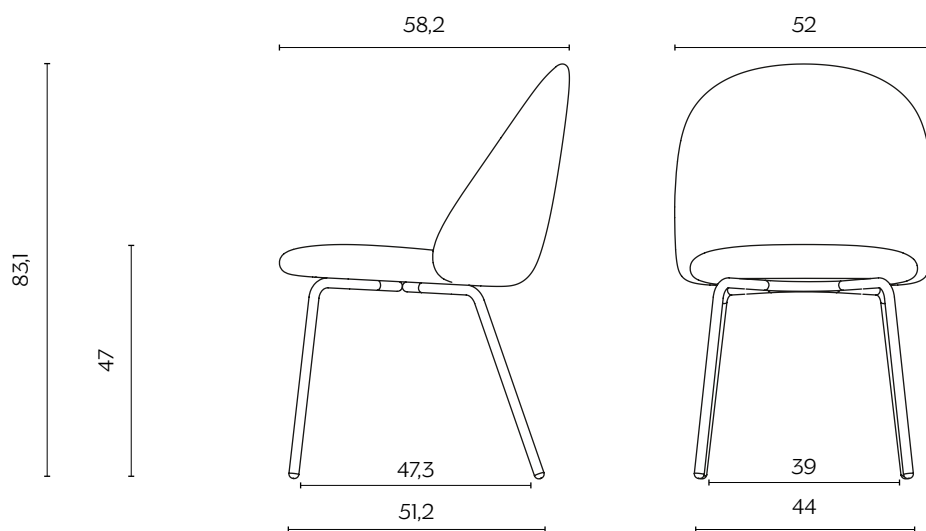

### IOLA WOOD

lunghezza | width: 52 cm  
larghezza | depth: 58,2 cm  
altezza | height: 83 cm  
altezza del sedile | seat height: 46,4 cm

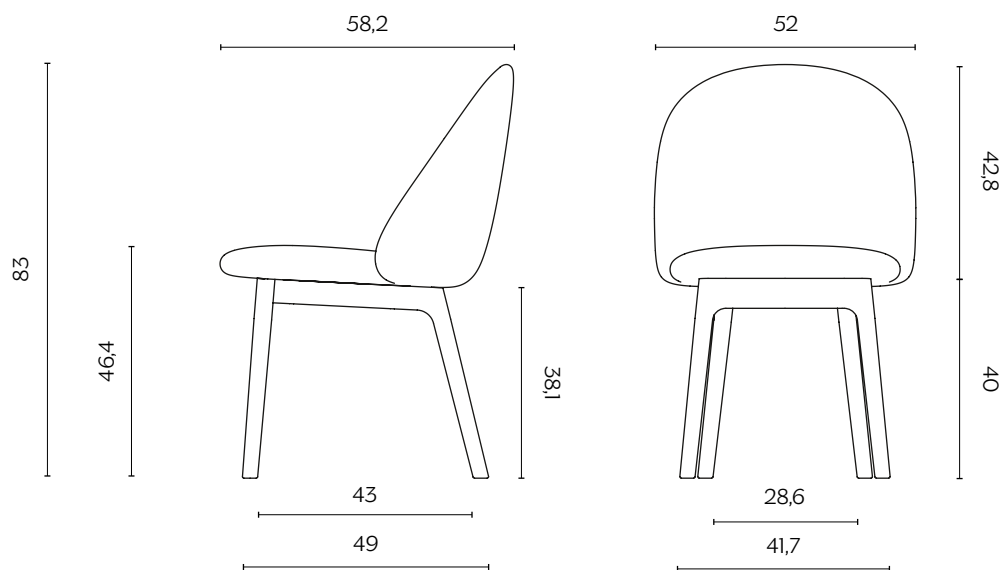

## DIMENSIONI | DIMENSIONS

### IOLA OFFICE

lunghezza | width: 52 cm

larghezza | depth: 58 cm

altezza | height: 83 cm

altezza del sedile | seat height: 46 cm

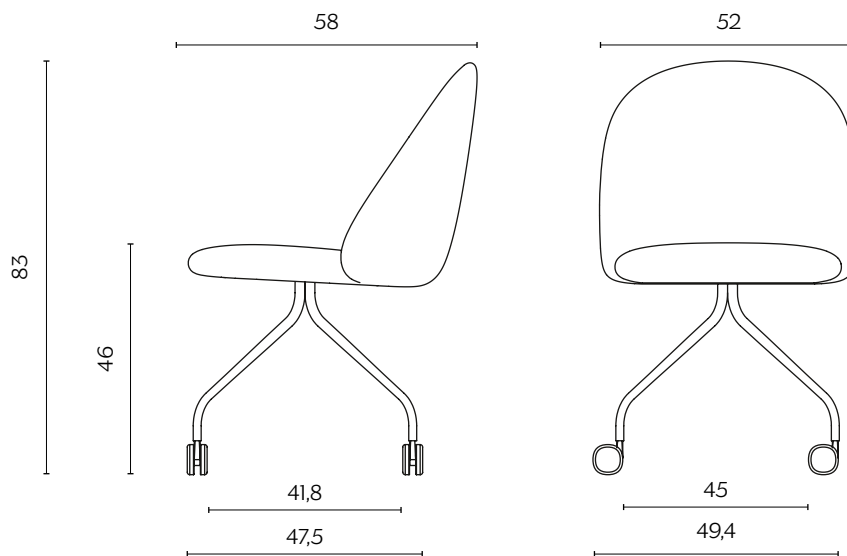

## FINITURE GAMBE | LEGS FINISHES

### METALLO | METAL



Oro Rosa Opaco  
Rose Gold Matt



Zincato  
Zinc-coated

finiture disponibili solo per il modello lola Basic  
/ finishes only available for the lola Basic model

### LEGNO | WOOD



Frassino  
Ash



Frassino nero  
Black ash

finiture disponibili solo per il modello lola Wood  
/ finishes only available for the lola Wood model

### LACCATO | LACQUER



Antracite  
NCS S7005-B20C

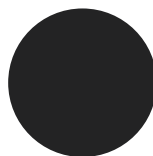

Nero  
NCS S9000-N

finiture disponibili per i modelli lola Basic and Office  
/ finishes available for the lola Basic and Office models

# TESSUTI | FABRICS

A

## LOOP

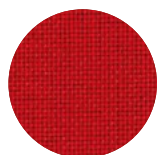

Rosso

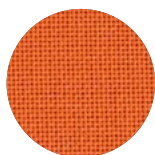

Arancione

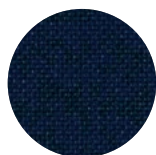

Blu notte



Cioccolato



Burro

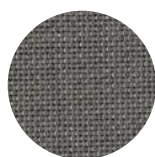

Grigio fumo



Nero

## TRAMÈ

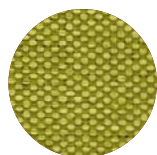

Mela

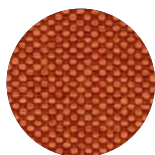

Arancio



Uva

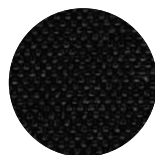

Nero



Beige

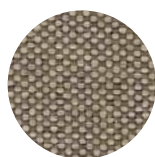

Tortora

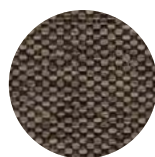

Grigio scuro

# TESSUTI | FABRICS

A

## CANVA



Ciallo

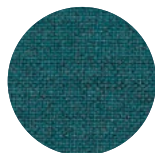

Petrolio

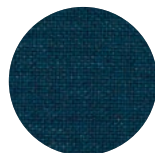

Blu



Sale



Sabbia

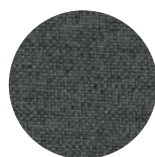

Grigio scuro

## PEPLO



Cannella



Rosso mattone



Giallo ocra



Grigio chiaro



Grigio tortora



Blu notte

# TESSUTI | FABRICS

B

## FLUKSO PLATINUM



Pesca

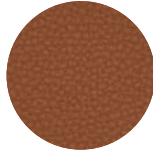

Mattone

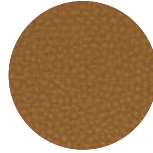

Nocciola



Verde

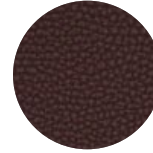

Porpora



Tortora



Nuvoloso

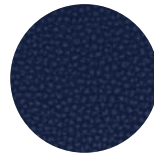

Blu

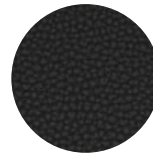

Nero

# TESSUTI | FABRICS

B

## VESCOM WILSON

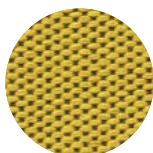

Ciallo elettrico

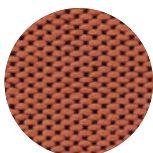

Rosé

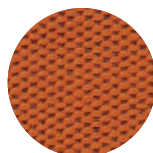

Energico

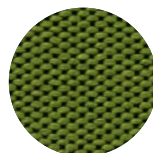

Laguna

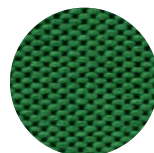

Prato

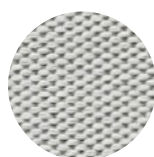

Neve

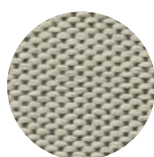

Sale e pepe

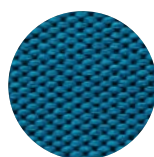

Zaffiro



Crafite

## VESCOM NORFOLK

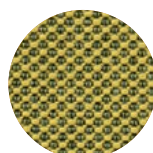

Ape

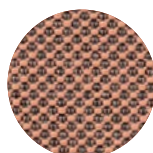

Rosa

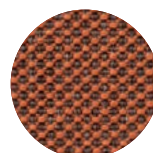

Mattone

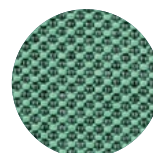

Latte e menta



Petrolio

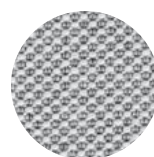

Chiaccio



Sale e pepe



Notte



Antracite



# TESSUTI | FABRICS

C

## KVADRAT RELATE

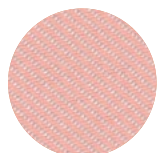

Rosa

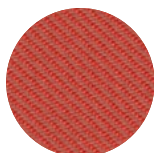

Rosso

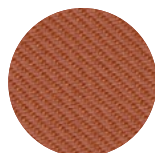

Terra



Snack



Menta

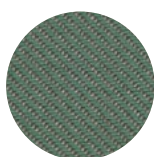

Verde bosco



Nuvolo



Grigio

## KVADRAT FIELD 2

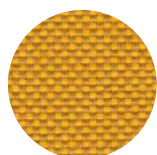

Zafferano

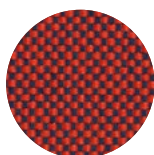

Ciliegia

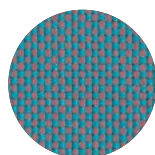

Zucchero

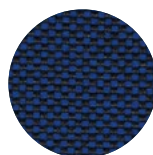

Blu

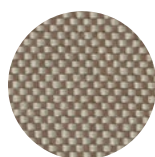

Nocciola

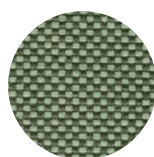

Menta

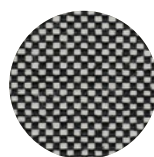

Sale e pepe

# TESSUTI | FABRICS

C

## VESCOM HARDING

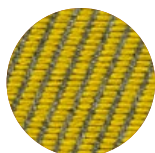

Ciallo

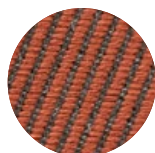

Rosso

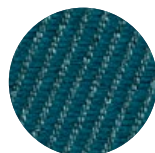

Petrolio



Nuvolo



Crigio chiaro

## VESCOM ROLLA

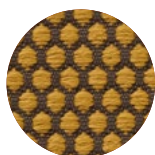

Mostarda

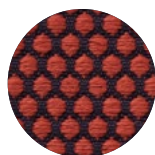

Ciliegia



Blu pavone



Latte

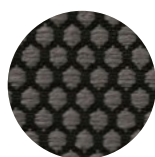

Crafite



Blu notte

## TESSUTI | FABRICS

C

### VESCOM MOORE



Margherita

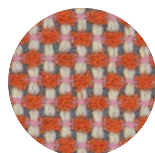

Lampone

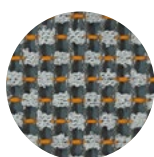

Saetta

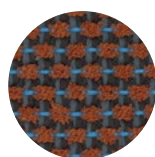

Uva

### TORRILANA GUBBIO

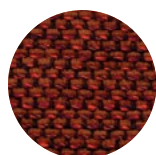

Ambra

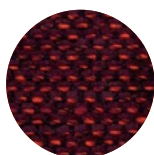

Bordeaux

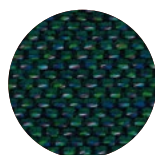

Verde Petrolio

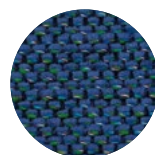

Blu elettrico

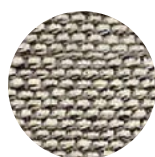

Sale e pepe



Castagna



Tortora

# TESSUTI | FABRICS

C

## BIG BOSS



Nuvola

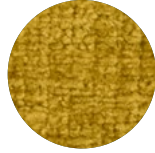

Senape



Nocciola

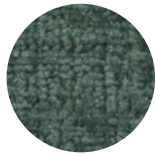

Turchese

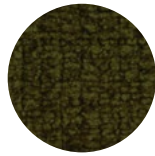

Muschio



Porpora

## MAHARAM METRIC

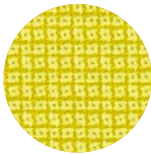

Canary

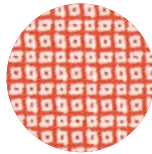

Cala



Lava

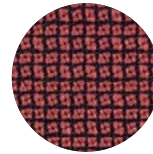

Kiln

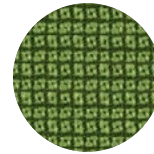

Alligator

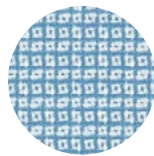

Middy

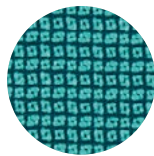

Talisman

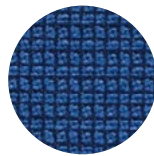

Seaport

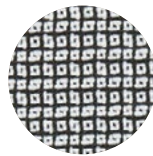

Film

# TESSUTI | FABRICS

D

## MAHARAM MERIT



Salmone

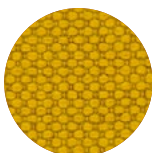

Ciallo

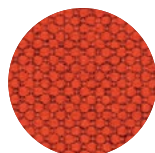

Rosso corallo

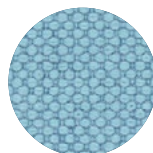

Celeste



Marrone

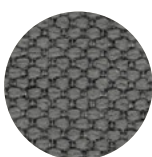

Grigio



Sale e pepe

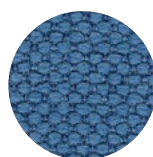

Blu cobalto

## ROHI SERA

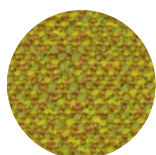

Tivoli

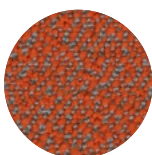

Glow

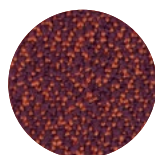

Berry

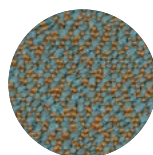

Mirage



Pepper

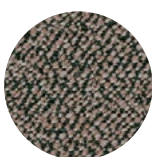

Walnut



Rosewood

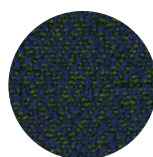

Mare

# TESSUTI | FABRICS

D

## ROHI MICA



Sanddorn

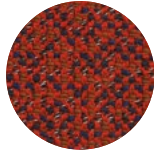

Indio

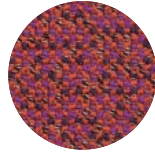

Brevia

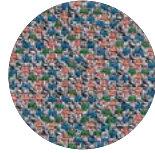

Papillon

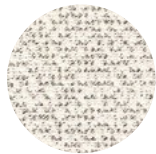

Calla



Crisp

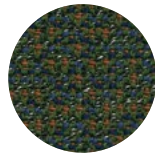

Jungle

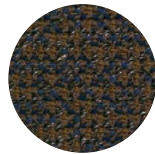

Secret

## ROHI CLEO



Lemon

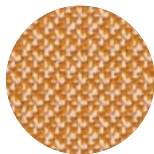

Peach

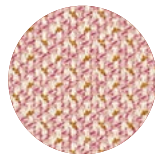

Flamingo

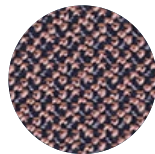

Azalee

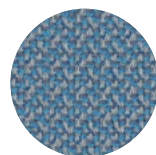

Sky



Ocean

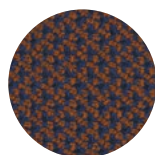

Magma



Pepper

## TESSUTI | FABRICS

D

### ERIMITI CLOUD



Panna



Noce



Nocciola



Bordeaux



Senape

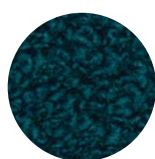

Petrolio

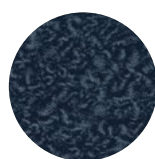

Blu notte

### TORRILANA BRIONNE

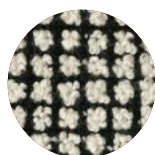

Black and white

## TESSUTI | FABRICS

E

### KVADRAT STEEL CUT TRIO 3

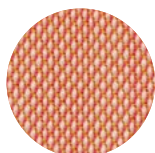

Pesca

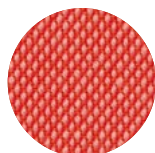

Arancia rossa

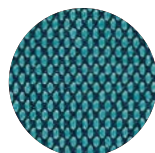

Pavone



Sale e pepe

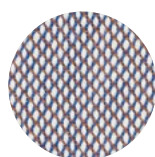

Elettricità

### VELLUTO

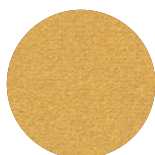

Soleggiato



Teddy



Cannella



Tobacco



Ostrica



Jeans



Notturmo

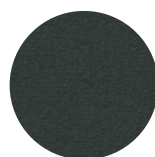

Balsamico



## TESSUTI | FABRICS

E

### DEDAR VOULEZ-VOUS

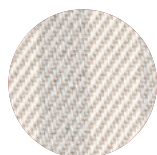

Sambuco



Cirasole

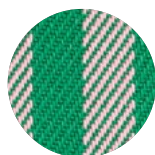

Fragola e menta



Tiramisu



Amarena



Tabacco



Noce di cocco

# TESSUTI | FABRICS

F

## KVADRAT SUUNTA

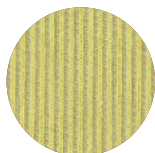

Primavera



Narcis

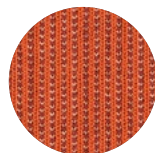

Tulip

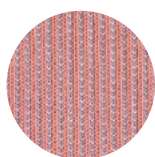

Peony

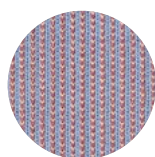

Crocus

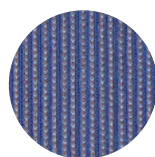

Iris

## KVADRAT TERO OUT

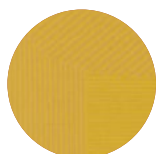

Sole



Verde prato



Borgogna



Notte



Panna



Nuvole

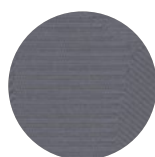

Robot



Tabacco

# TESSUTI | FABRICS

F

## MAHARAM OXBOW



Dianthus

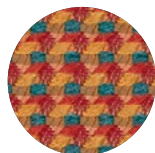

Montage

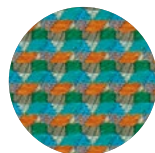

Nouveau

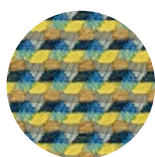

Legume

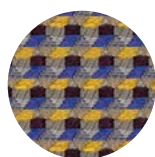

Module

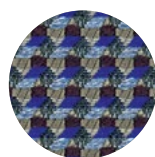

Trope

## SAHCO ZERO

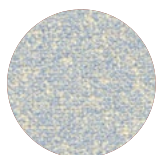

Zucchero



Candido

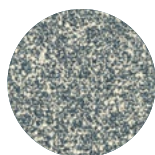

Petrolio

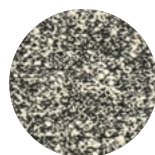

Sale e pepe

## TESSUTI | FABRICS

C

### DEDAR TIGER BEAT

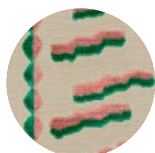

Fragola menta

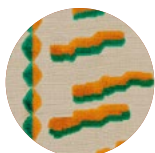

Papaya



Fauve



Tabacco



Fumo

### DEDAR AMULETO



Corallo



Rubino



Smeraldo



Alabastro



Occhio di tigre